



RLD 30V UMF Series PTC Devices

RLD 30V UMF Series PTC Devices

Description

The UMF series provides radial leaded resettable over-current protection with holding current from 0.9A to 12.0A. This series is suitable for wide range of applications in modern electronics and automotive industry.

Features





- RoHS compliant and lead-free
- Halogen-free
- Fast time-to-trip
- 30Vdc operating voltage
- 40A maximum short current
- Meet all USB protection requirements





Applications

- Powered USB for POS and IPC
- USB hubs, ports and peripherals
- General electronics
- Computers & peripherals
- Automotive applications
- Motor protection

Agency Approval and Environmental Compliance



Agency	File Number	Regulation	Standard
	E201431		2011/65/EU
	R50103284		IEC 61249-2-21:2003

Electrical Characteristics

Part Number	I _{hold} (A)	I _{trip} (A)	V _{max} (Vdc)	I _{max} (A)	P _{d typ} (W)	Maximum Time To Trip		Resistance		Agency Approval	
						Current (A)	Time (Sec.)	R _{min} (Ω)	R _{1max} (Ω)		
RLD30P090UMF	0.90	1.80	30	100	0.6	4.50	3.0	0.080	0.360	✓	✓
RLD30P110UMF	1.10	2.20	30	100	0.7	5.50	3.2	0.060	0.250	✓	✓
RLD30P135UMF	1.35	2.70	30	100	0.9	6.75	3.5	0.045	0.180	✓	✓
RLD30P160UMF	1.60	3.20	30	100	1.1	8.00	3.6	0.035	0.150	✓	✓
RLD30P185UMF	1.85	3.70	30	100	1.1	9.25	3.7	0.032	0.140	✓	✓
RLD30P250UMF	2.50	5.00	30	100	1.3	12.5	3.8	0.028	0.120	✓	✓
RLD30P300UMF	3.00	6.00	30	100	2.2	15.0	4.0	0.024	0.090	✓	✓
RLD30P400UMF	4.00	8.00	30	100	2.6	20.0	4.7	0.014	0.060	✓	✓
RLD30P500UMF	5.00	9.00	30	100	3.0	25.0	5.0	0.012	0.050	✓	✓
RLD30P600UMF	6.00	10.0	30	100	3.6	30.0	6.0	0.011	0.040	✓	✓
RLD30P700UMF	7.00	12.0	30	100	3.8	35.0	6.5	0.008	0.030	✓	✓
RLD30P800UMF	8.00	14.0	30	100	4.0	40.0	7.0	0.006	0.025	✓	✓
RLD30P900UMF	9.00	15.0	30	100	4.3	45.0	8.0	0.005	0.020	✓	✓

RLD 30V UMF Series PTC Devices

(Continued)

Part Number	I _{hold} (A)	I _{trip} (A)	V _{max} (Vdc)	I _{max} (A)	P _{d typ} (W)	Maximum Time To Trip		Resistance		Agency Approval	
						Current (A)	Time (Sec.)	R _{min} (Ω)	R _{1max} (Ω)		
RLD30P1000UMF	10.0	16.0	30	100	5.1	50.0	9.0	0.005	0.015	✓	✓
RLD30P1200UMF	12.0	18.0	30	100	6.2	60.0	10.0	0.004	0.012	✓	✓

Note on Electrical Characteristics

■ Vocabulary

I_{hold} = Hold current: maximum current device will pass without tripping in 23°C still air.

I_{trip} = Trip current: minimum current at which the device will trip in 23°C still air.

V_{max} = Maximum voltage device can withstand without damage at rated current (I_{max})

I_{max} = Maximum fault current device can withstand without damage at rated voltage (V_{max})

P_{d typ} = Typical power dissipated from device when in the tripped state at 23°C still air.

R_{min} = Minimum resistance of device in initial (un-soldered) state.

R_{1max} = Maximum resistance of device at 23°C measured one hour after tripping or reflow soldering of 260°C for 20 sec.

■ **Caution: Operation beyond the specified rating may result in damage and possible arcing and flame.**

■ Specifications are subject to change without notice.

RLD 30V UMF Series PTC Devices

Polymeric PTC Selecting Guide

■ Determine the following operating parameters for the circuits:

- Normal operating current (I_{hold})
- Maximum interrupt current (I_{max})
- Maximum circuit voltage (V_{max})
- Normal operating temperature surrounding device (min°C/max°C)

■ Select the device form factor and dimension suitable for the application:

- Surface Mount Device (SMD)
- Axial Leaded Device (ALD)
- Other Customized Form Factors
- Radial Leaded Device (RLD)
- DISC Device

■ Compare the maximum rating for V_{max} and I_{max} of the PPTC device with the circuit in application and make sure the circuit's requirement does not exceed the device rating.

■ Check that PPTC device's trip time (time-to-trip) will protect the circuit.

■ Verify that the circuit operating temperature is within the PPTC device's normal operating temperature range.

■ Verify the performance and suitability of the chosen PPTC device in the application.

WARNING

■ **Mechanical Stress**

- PPTC devices will undergo a thermal expansion during fault condition. If PPTC devices are installed or placed in an application where the space between PPTC devices and the surrounding materials (e.g., covering materials, packaging materials, encapsulate materials and the like) is insufficient, it will cause an inhibiting effect upon the thermal expansion. Pressing, twisting, bending and other kinds of mechanical stress will also adversely affect the performance of the PPTC devices, and shall not be used or applied.

■ **Chemical Pollutants**

- Silicone-based oils, oils, solvents, gels, electrolytes, fuels, acids, and the like will adversely affect the properties of PPTC devices, and shall not be used or applied.

■ **Electronic and Thermal Effect**

- PPTC devices are secondary protection devices and are used solely for sporadic, accidental over-current or over-temperature error condition, and shall NOT be used if or when constant or repeated fault conditions (such fault conditions may be caused by, among others, incorrect pin-connection of a connector) or over-extensive trip events may occur.
- PPTC devices are different from fuses and, when a fault condition occurs, will go into high-resistance state and do not open circuit, in which case the voltage at such PPTC devices may reach a hazardous level.
- Operation over the maximum rating or other forms of improper use may cause failure, arcing, flame and/or other damage to the PPTC devices.
- Conductive material contamination, such as metal particle, may induce shortage, flame or arcing.
- Due to the inductance, the operation circuits may generate a circuit voltage (Ldi/dt) above the rated voltage of PPTC devices, which shall not be used under such circumstances.

■ **General**

- Customers shall evaluate and test the properties of PPTC devices independently to verify and ensure that their individual applications will be met.
- The performance of PPTC devices will be adversely affected if they are improperly used under electronic, thermal and/or mechanical procedures and/or conditions non-conformant to those recommended by manufacturer.
- Customers shall be responsible for determining whether it is necessary to have back-up, failsafe and/or fool-proof protection to avoid or minimize damage that may result from extra-ordinary, irregular function or failure of PPTC devices.
- Any and all responsibilities and liabilities are disclaimed if any item under this notice of warning is not complied with.

RLD 30V UMF Series PTC Devices

Average Time-to-Trip Curves

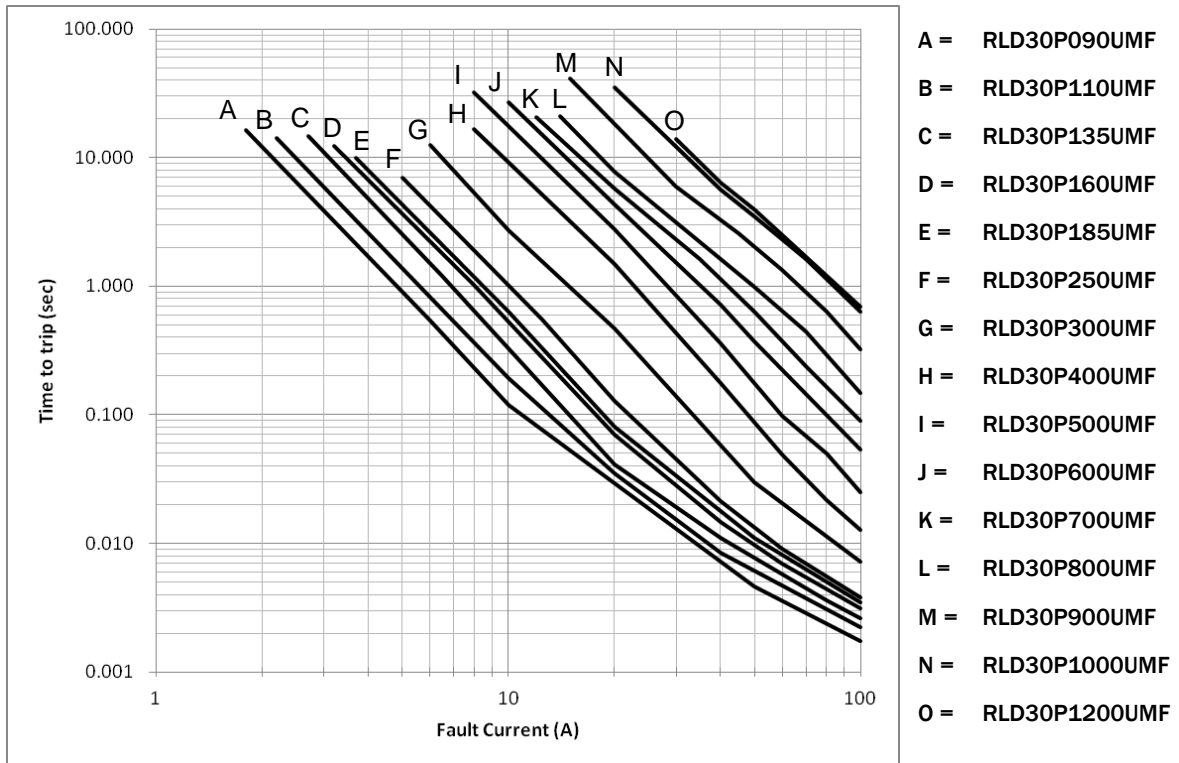

RLD 30V UMF Series PTC Devices

Thermal Derating Curve

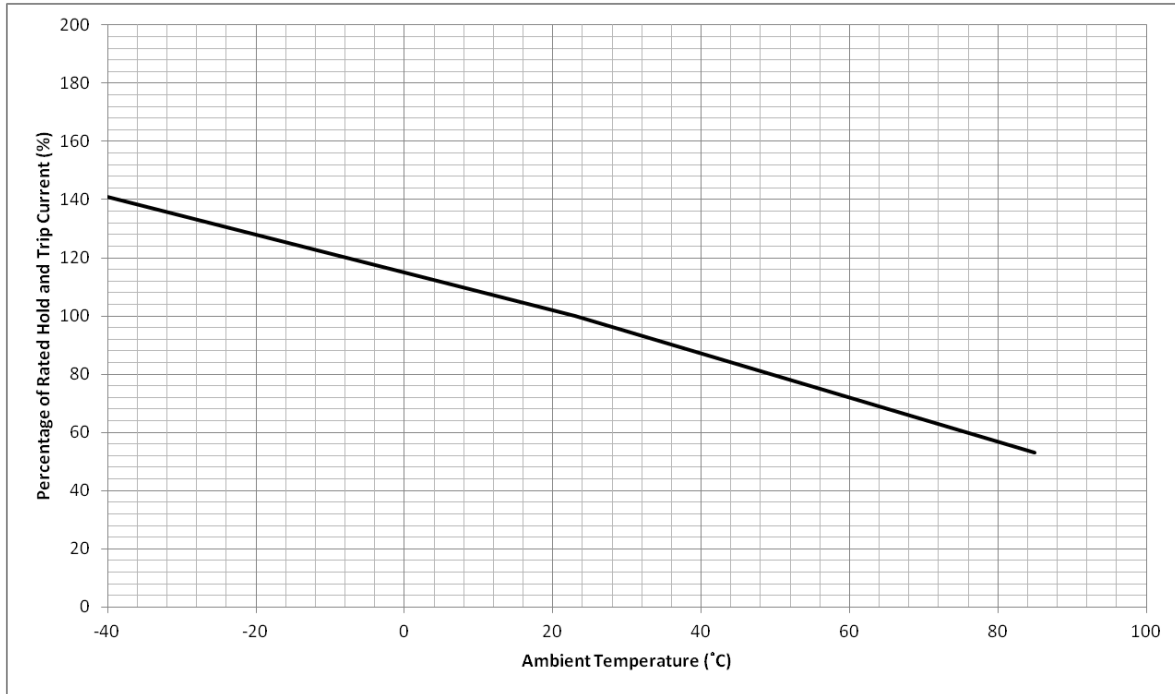

Thermal Derating Table

Recommended Hold Current (A) vs. Ambient Temperature (°C)

Part Number	Ambient Operation Temperature								
	-40 °C	-20 °C	0 °C	23 °C	40 °C	50 °C	60 °C	70 °C	85 °C
RLD30P090UMF	1.27	1.15	1.03	0.90	0.78	0.72	0.65	0.58	0.48
RLD30P110UMF	1.55	1.41	1.26	1.10	0.96	0.87	0.79	0.71	0.58
RLD30P135UMF	1.90	1.73	1.55	1.35	1.18	1.07	0.97	0.87	0.72
RLD30P160UMF	2.26	2.05	1.84	1.60	1.39	1.27	1.15	1.03	0.85
RLD30P185UMF	2.61	2.37	2.13	1.85	1.61	1.47	1.33	1.19	0.98
RLD30P250UMF	3.5	3.2	2.9	2.5	2.2	2.0	1.8	1.6	1.3
RLD30P300UMF	4.2	3.8	3.4	3.0	2.6	2.4	2.2	1.9	1.6
RLD30P400UMF	5.6	5.1	4.6	4.0	3.5	3.2	2.9	2.6	2.1
RLD30P500UMF	7.1	6.4	5.7	5.0	4.4	4.0	3.6	3.2	2.7
RLD30P600UMF	8.5	7.7	6.9	6.0	5.2	4.8	4.3	3.9	3.2
RLD30P700UMF	9.9	9.0	8.0	7.0	6.1	5.6	5.0	4.5	3.7
RLD30P800UMF	11.3	10.2	9.2	8.0	7.0	6.4	5.8	5.1	4.2
RLD30P900UMF	12.7	11.5	10.3	9.0	7.8	7.2	6.5	5.8	4.8
RLD30P1000UMF	14.1	12.8	11.5	10.0	8.7	8.0	7.2	6.4	5.3
RLD30P1200UMF	16.9	15.4	13.8	12.0	10.5	9.5	8.6	7.7	6.4

RLD 30V UMF Series PTC Devices

Physical Dimensions (mm.)

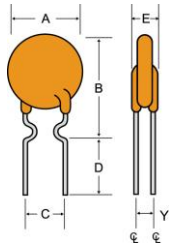

Fig. 1

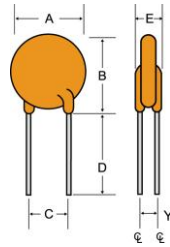

Fig. 2

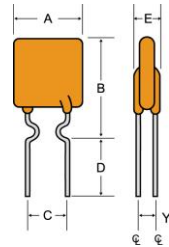

Fig. 3

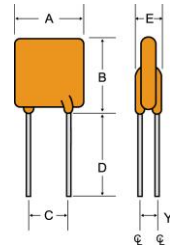

Fig. 4

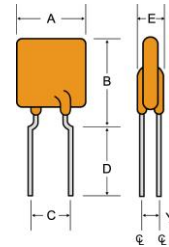
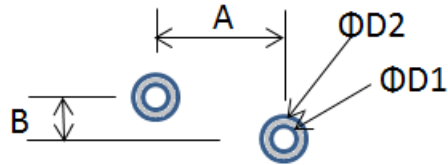

Fig. 5

Part Number	A Max.	B Max.	C Typ.	D Min.	E Max.	Y	Fig.	Lead Dia.
						Typ.		
RLD30P090UMF	6.9	11.7	5.1±0.7	7.6	3.0	0.9	1	0.51
RLD30P090UMF-S	6.9	9.4	5.1±0.7	7.6	3.0	0.9	2	0.51
RLD30P110UMF	7.6	12.0	5.1±0.7	7.6	3.0	0.9	1	0.51
RLD30P110UMF-S	7.6	9.8	5.1±0.7	7.6	3.0	0.9	2	0.51
RLD30P135UMF	7.5	11.8	5.1±0.7	7.6	3.0	0.9	3	0.51
RLD30P135UMF-S	7.5	9.8	5.1±0.7	7.6	3.0	0.9	4	0.51
RLD30P160UMF	7.8	12.2	5.1±0.7	7.6	3.0	0.9	3	0.51
RLD30P160UMF-S	7.8	10.0	5.1±0.7	7.6	3.0	0.9	4	0.51
RLD30P185UMF	7.8	13.1	5.1±0.7	7.6	3.0	0.9	3	0.51
RLD30P185UMF-S	7.8	10.6	5.1±0.7	7.6	3.0	0.9	4	0.51
RLD30P250UMF	7.8	14.2	5.1±0.7	7.6	3.0	0.9	3	0.51
RLD30P250UMF-S	7.8	12.0	5.1±0.7	7.6	3.0	0.9	4	0.51
RLD30P300UMF	8.9	13.5	5.1±0.7	7.6	3.6	1.2	3	0.81
RLD30P300UMF-S	8.9	11.3	5.1±0.7	7.6	3.6	1.2	4	0.81
RLD30P400UMF	10.2	15.7	5.1±0.7	7.6	3.6	1.2	3	0.81
RLD30P400UMF-S	10.2	13.8	5.1±0.7	7.6	3.6	1.2	4	0.81
RLD30P500UMF	12.1	18.3	5.1±0.7	7.6	3.6	1.2	3	0.81
RLD30P500UMF-S	12.1	16.0	5.1±0.7	7.6	3.6	1.2	4	0.81
RLD30P600UMF	13.0	19.0	5.1±0.7	7.6	3.6	1.2	3	0.81
RLD30P600UMF-S	13.0	16.5	5.1±0.7	7.6	3.6	1.2	4	0.81
RLD30P700UMF	14.5	22.0	5.1±0.7	7.6	3.6	1.2	3	0.81
RLD30P700UMF-S	14.5	18.3	5.1±0.7	7.6	3.6	1.2	4	0.81
RLD30P800UMF	14.5	25.6	5.1±0.7	7.6	3.6	1.2	3	0.81
RLD30P800UMF-S	14.5	23.0	5.1±0.7	7.6	3.6	1.2	4	0.81
RLD30P900UMF	17.0	26.8	10.2±1.0	7.6	3.6	1.2	3	0.81
RLD30P900UMF-S	17.0	23.4	10.2±1.0	7.6	3.6	1.2	4	0.81
RLD30P1000UMF	19.5	28.6	10.2±1.0	7.6	3.6	1.2	3	0.81
RLD30P1000UMF-S	19.5	25.0	10.2±1.0	7.6	3.6	1.2	4	0.81
RLD30P1200UMF	19.8	25.6	10.2±1.0	7.6	4.0	1.4	4	1.00

RLD 30V UMF Series PTC Devices

Recommend Pad Layout (mm)



Part Number	A (Typ.)	B (Typ.)	D1 (Typ.)	D2 (Typ.)
RLD30P090UMF	5.1	0.9	1.0	2.5
RLD30P110UMF	5.1	0.9	1.0	2.5
RLD30P135UMF	5.1	0.9	1.0	2.5
RLD30P160UMF	5.1	0.9	1.0	2.5
RLD30P185UMF	5.1	0.9	1.0	2.5
RLD30P250UMF	5.1	0.9	1.0	2.5
RLD30P300UMF	5.1	1.2	1.5	3.5
RLD30P400UMF	5.1	1.2	1.5	3.5
RLD30P500UMF	5.1	1.2	1.5	3.5
RLD30P600UMF	5.1	1.2	1.5	3.5
RLD30P700UMF	5.1	1.2	1.5	3.5
RLD30P800UMF	5.1	1.2	1.5	3.5
RLD30P900UMF	10.2	1.2	1.5	3.5
RLD30P1000UMF	10.2	1.2	1.5	3.5
RLD30P1200UMF	10.2	1.4	1.8	4.0

RLD 30V UMF Series PTC Devices

Wave Soldering Parameters

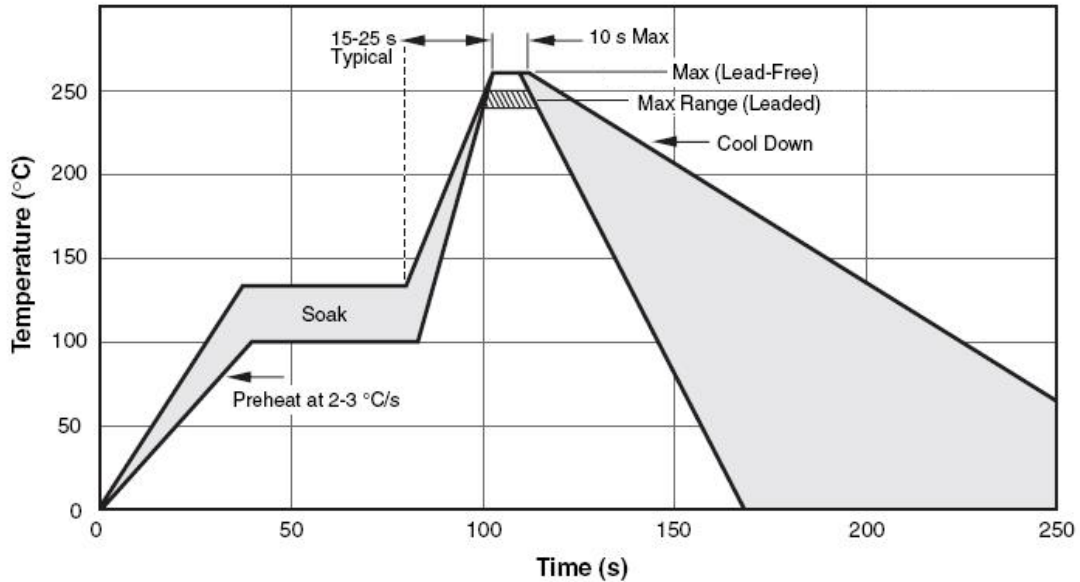

Profile Feature	Pb-Free Assembly
Average Ramp-Up Rate (T_{smax} to T_P)	4°C/second max.
Preheat	
-Temperature Min (T_{smin})	100°C
-Temperature Max (T_{smax})	125°C
-Time (T_{smin} to T_{smax})	60-180 seconds
Peak Temperature (T_P)	265°C
Max Time at Peak Temperature (t_P)	5 seconds
Ramp-Down Rate	6 °C /second max.
Time 25°C to Peak Temperature	5 minutes max.
Storage Condition	0°C ~35°C, ≤ 80%RH

Note: If the wave soldering temperatures exceed the recommended profile, devices may not meet the performance requirements.

RLD 30V UMF Series PTC Devices

Environmental Specifications

Operating Temperature	-40°C to +85 °C
Maximum Device Surface Temperature in Tripped State	125°C
Passive Aging	+85°C , 1000 hours ±5% typical resistance change
Humidity Aging	+85°C , 85%R.H. 1000 hours ±5% typical resistance change
Thermal Shock	MIL-STD-202 Method 107G +85°C /-40°C 10 times -30% typical resistance change
Solvent Resistance	MIL-STD-202, Method 215 No change
Vibration	MIL-STD-883C, Method 2007.1, Condition A No change
Moisture Sensitivity Level	Level 1, J-STD-020C

Physical Specifications

Lead Material	P090UMF-P160UMF: Tin-plated copper clad steel P185UMF-P1200UMF: Tin-plated copper
Soldering Characteristics	Solderability per MIL-STD-202, Method 208E
Insulating Material	Cured, flame retardant epoxy polymer meets UL94V-0 requirements.

RLD 30V UMF Series PTC Devices

Tape and Reel Specifications: EIA468-B/IEC60286-2

Dimension Description	EIA Mark	IEC Mark	Dimensions	
			Dim.(mm)	Tol.(mm)
Carrier tape width	W	W	18	-0.5/+1.0
Hold down tape width	W ₄	W ₀	11	min.
Top distance between tape edges	W ₆	W ₂	3	max.
Sprocket hole position	W ₅	W ₁	9	-0.5+0.75
Sprocket hole diameter*	D ₀	D ₀	4	-0.32/+0.2
Abscissa to plane(straight lead)	H	H	18.5	±3.0
Abscissa to plane(kinked lead)	H ₀	H ₀	16	±0.5
Abscissa to top P090UMF-P400UMF	H ₁	H ₁	32.2	max.
Abscissa to top P500UMF-P1200UMF	H ₁		47.5	max.
Overall width without lead protrusion: P090UMF-P400UMF	C ₁		42.5	max.
Overall width without lead protrusion: P500UMF-P1200UMF			57	
Overall width with lead protrusion: P090UMF-P400UMF	C ₂		43.2	max.
Overall width with lead protrusion: P500UMF-P1200UMF			58	
Lead protrusion	L ₁	l ₁	1.0	max.
Protrusion of cut out	L	L	11	max.
Protrusion beyond hold-down tape	l ₂	l ₂	Not specified	
Sprocket hole pitch: P090UMF-P600UMF	P ₀	P ₀	12.7	±0.3
Sprocket hole pitch: P700UMF-P1200UMF	P ₀	P ₀	25.4	±0.5
Pitch tolerance			20 consecutive.	±1
Device pitch:P090UMF-P600UMF			12.7	
Device pitch:P700UMF-P1200UMF			25.4	
Tape thickness	t	t	0.9	max.
Tape thickness with splice	t ₁		2.0	max.
Splice sprocket hole alignment			0	±0.3
Body lateral deviation	Δh	Δh	0	±1.0
Body tape plane deviation	Δp	Δp	0	±1.3
Ordinate to adjacent component lead*: P090UMF-P800UMF	P ₁	P ₁	3.81	±0.7
Ordinate to adjacent component lead*: P900UMF-P1200UMF			7.62	±0.7
Lead spacing:P090UMF-P800UMF	F	F	5.08	±0.8
Lead spacing:P900UMF-P1200UMF	F	F	10.18	±0.8
Reel width P090UMF-P400UMF	w ₂	w	56	max.
Reel width P500UMF-P1200UMF	w ₂	w	63.5	max.
Reel diameter	a	d	370	max.
Space between flanges less device*	w ₁		4.75	-3.25/+9.25
Arbor hole diameter	c	f	26	±12.0
Core diameter*	n	h	91	max.
Box			56/372/372	max.
Consecutive missing places			None	
Empty places per reel			0.1%max.	

RLD 30V UMF Series PTC Devices

Tape and Reel Specifications: EIA468-B/IEC60286-2

(Continued)

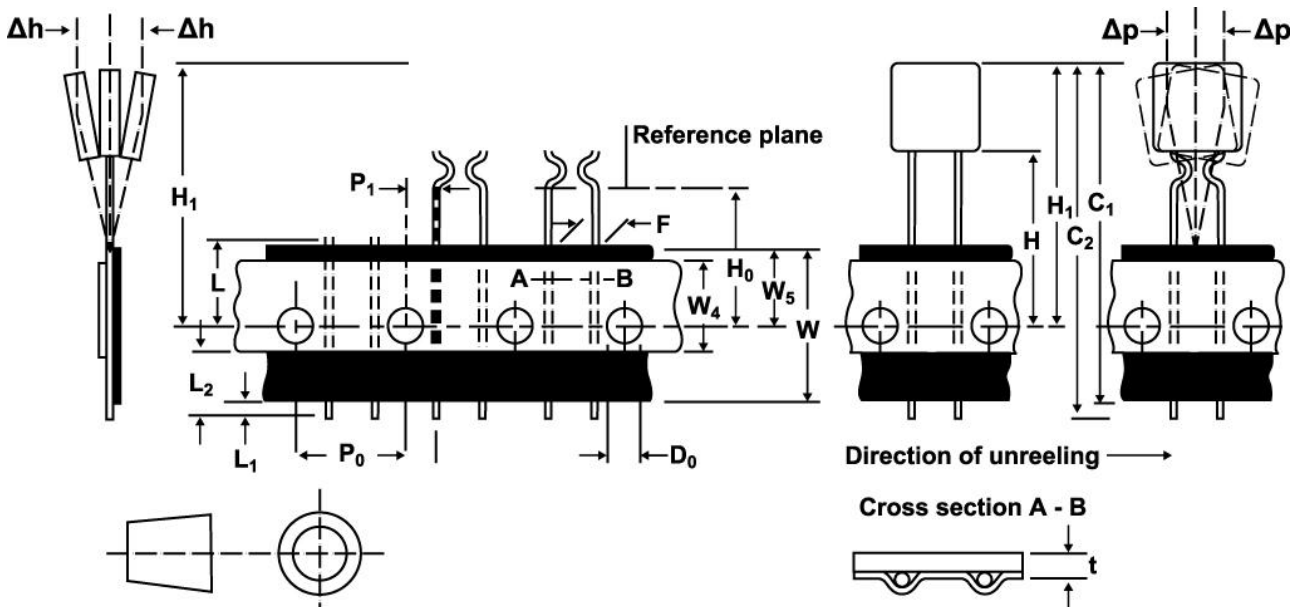

Fig. 1

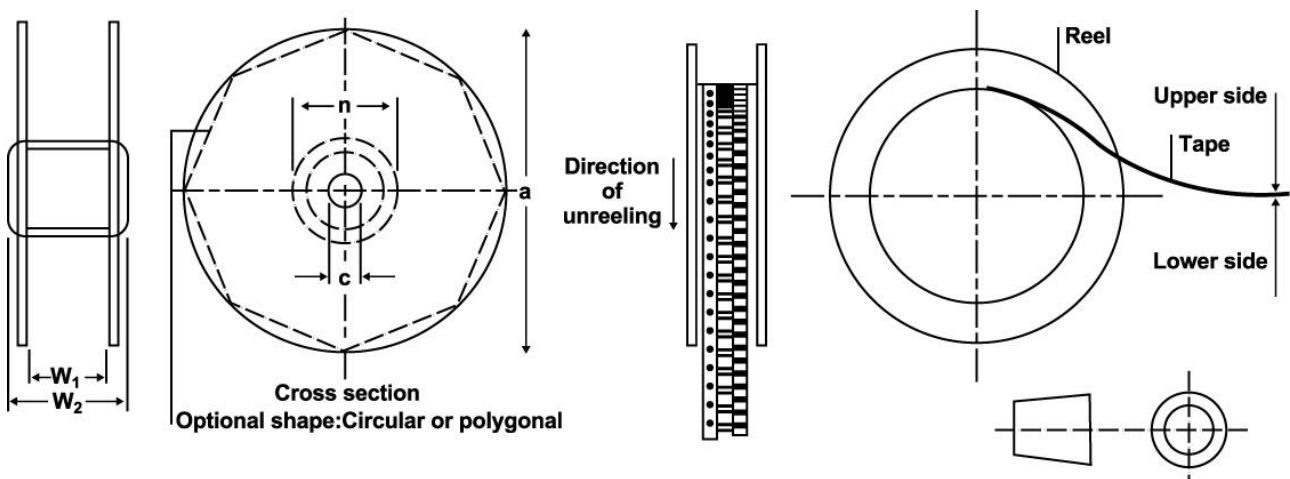
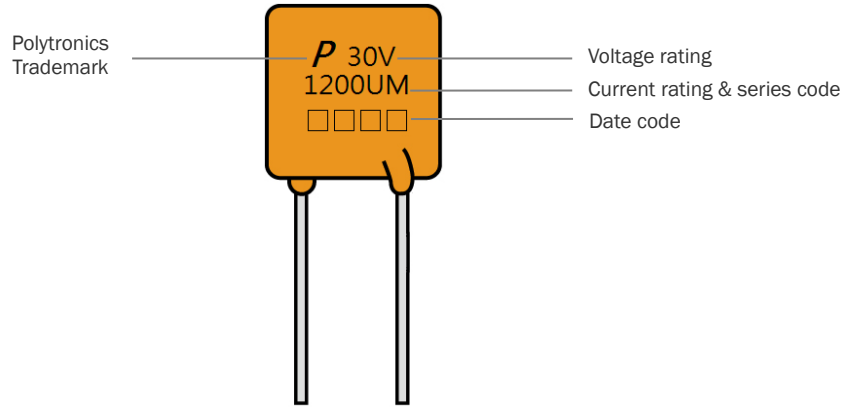

Fig. 2

RLD 30V UMF Series PTC Devices

Marking on Device



Part Ordering Number System

RLD 30 P □□□ **UMF -** □□

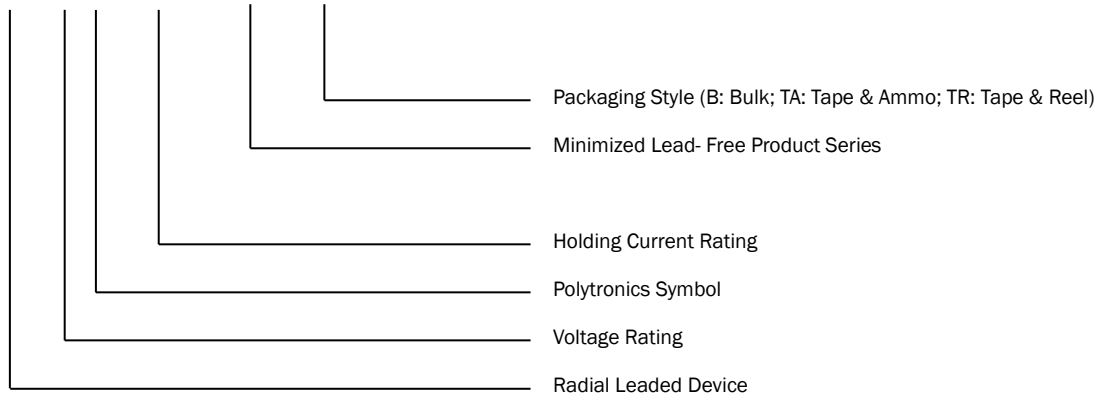

RLD 30V UMF Series PTC Devices

Packaging Quantity

Part Number	Ordering Code	Bag Quantity	Reelpack Quantity	Ammopack Quantity
RLD30P090UMF	RLD30P090UMF-B	500		
	RLD30P090UMF-TR		2000	
	RLD30P090UMF-TA			2000
RLD30P110UMF	RLD30P110UMF-B	500		
	RLD30P110UMF-TR		2000	
	RLD30P110UMF-TA			2000
RLD30P135UMF	RLD30P135UMF-B	500		
	RLD30P135UMF-TR		2000	
	RLD30P135UMF-TA			2000
RLD30P160UMF	RLD30P160UMF-B	500		
	RLD30P160UMF-TR		2000	
	RLD30P160UMF-TA			2000
RLD30P185UMF	RLD30P185UMF-B	500		
	RLD30P185UMF-TR		2000	
	RLD30P185UMF-TA			2000
RLD30P250UMF	RLD30P250UMF-B	500		
	RLD30P250UMF-TR		2000	
	RLD30P250UMF-TA			2000
RLD30P300UMF	RLD30P300UMF-B	500		
	RLD30P300UMF-TR		1500	
	RLD30P300UMF-TA			1500
RLD30P400UMF	RLD30P400UMF-B	500		
	RLD30P400UMF-TR		1500	
	RLD30P400UMF-TA			1500
RLD30P500UMF	RLD30P500UMF-B	500		
	RLD30P500UMF-TR		1500	
	RLD30P500UMF-TA			1500
RLD30P600UMF	RLD30P600UMF-B	500		
	RLD30P600UMF-TR		1500	
	RLD30P600UMF-TA			1500
RLD30P700UMF	RLD30P700UMF-B	200		
	RLD30P700UMF-TR		1000	
	RLD30P700UMF-TA			1000
RLD30P800UMF	RLD30P800UMF-B	200		
	RLD30P800UMF-TR		1000	
	RLD30P800UMF-TA			1000
RLD30P900UMF	RLD30P900UMF-B	200		
	RLD30P900UMF-TR		1000	
	RLD30P900UMF-TA			1000
RLD30P1000UMF	RLD30P1000UMF-B	200		
	RLD30P1000UMF-TR		1000	
	RLD30P1000UMF-TA			1000
RLD30P1200UMF	RLD30P1200UMF-B	200		
	RLD30P1200UMF-TR		1000	
	RLD30P1200UMF-TA			1000